











-  Sollevatore mobile monocolonna
-  **Mobile single post lift**
-  Mobile Einsäulen-Hebebühne
-  Pont élévateur mobile mono colonne
-  Elevador móvil monocolumna



-  Sicurezze meccaniche, elettriche • ed idrauliche • Sollevatore multi-uso con piattaforma di carico estremamente versatile • Mobile, quindi utilizzabile sia in interno che esterno • Adatto per meccanici, carrozzieri, gommisti stazioni di servizio ed elettrauto • Adatto per interventi veloci • Adatto per interventi sia sulla carrozzeria che sulla parte meccanica • Adatto per posizionare l'autovettura sui banchi di riscontro • Dimensioni compatte • Funzionamento: elettroidraulico
-  **Equipped with mechanical, electrical and hydraulic safety devices • Multi-purpose vehicle lift with very versatile load platform • Mobile, thus suitable for indoor and outdoor • Suitable for mechanics, body shops, tyre dealers, petrol stations, vehicle electricians • Rapidly available for any lifting job • Can lift the vehicles to easily operate both on the body and on the mechanical part • Suitable to fit cars on car benches • Compact • Operation: electro-hydraulic**
-  Mit mechanischen, elektrischen und hydraulischen Sicherheitsvorrichtungen • Mehrzweck-Fahrzeugheber mit vielseitig einsetzbarer Hubplattform • Fahrbar; kann sowohl im Innern als auch im Aussenbereich eingesetzt werden • Geeignet für Garagen, Karosseriespengler, Tankstellen, Autoelektriker usw. • Geeignet für Schnelleinsätze • Geeignet für Arbeiten an der Karosserie und an der Fahrzeugmechanik • Geeignet zum Auflegen von PKW's auf Richtbänke • Kompakt • Funktionsweise: elektrohydraulisch
-  Équipé avec sécurités mécaniques, électriques et hydrauliques • Elévateur multi-usage avec plateforme de levage extrêmement versatile • Mobile, donc utilisable aussi bien à l'intérieur qu'à l'extérieur • Indiqué pour mécaniciens, carrossiers, stations-service, électriciens auto etc. • Indiqué pour levages rapides • Indiqué pour travaux aussi bien sur la carrosserie que sur les parties mécaniques des voitures • Utile pour placer les voitures sur les bancs de redressement • Compact • Fonctionnement: électrohydraulique
-  Seguridades mecánicas, eléctricas e hidráulicas • Elevador multiuso con plataforma de carga extremadamente versátil • Móvil, por lo tanto utilizable tanto en interiores como en exteriores • Apto para mecánicos, planchistas, especialistas en neumáticos, estaciones de servicio y talleres de electricidad del automóvil • Apto para actuaciones rápidas • Apto para actuaciones tanto en la carrocería como en la parte mecánica • Apto para colocar el vehículo en los bancos de enderezamiento • Dimensiones compactas • Funcionamiento: electro-hidráulico

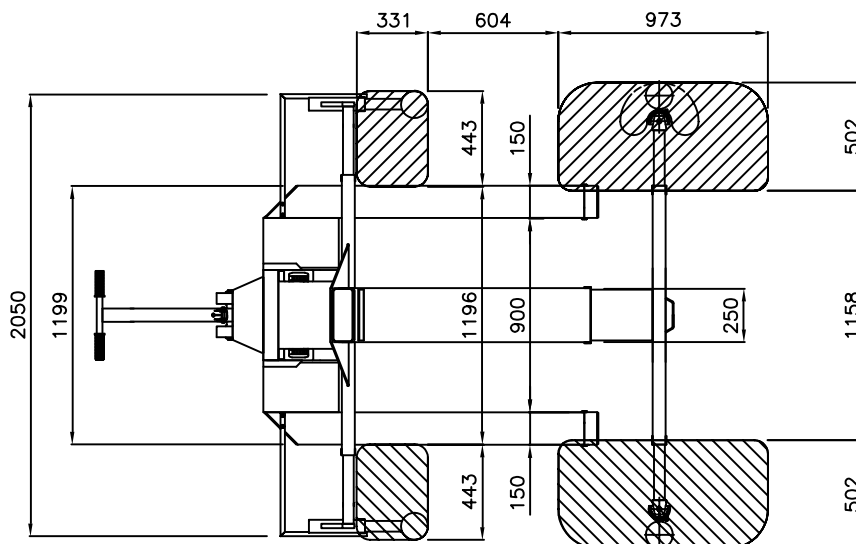
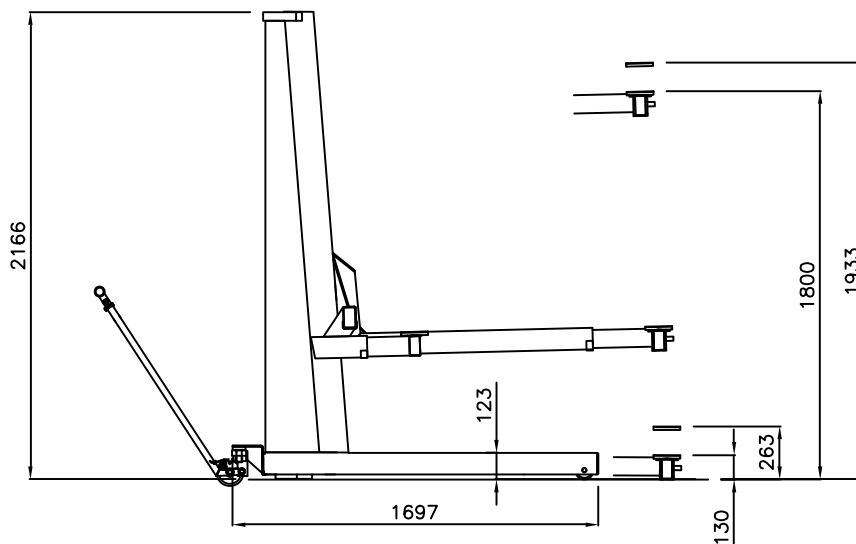

Dati tecnici	Technical data	Technische Eigenschaften	Caractéristiques techniques	Datos técnicos	
Portata	<b>Capacity</b>	Tragfähigkeit	Capacité	Capacidad	<b>2.500 kg</b>
Peso	<b>Weight</b>	Gewicht	Poids	Peso	<b>700 kg</b>
Salita/Discesa	<b>Lifting/lowering</b>	Hub/Senkzeit	Levage/descente	Subida/Bajada	<b>25/45 s</b>
Altezza di sollevamento	<b>Lifting height</b>	Hubhöhe	Hauteur de levage	Altura de elevación	<b>1933 mm</b>
Altezza minima	<b>Min. height</b>	Mindesthöhe	Hauteur min.	Altura minima	<b>130 mm</b>
Motore	<b>Motor</b>	Motorleistung	Puissance moteur	Motor	<b>2,2 kW - 3 ph 230 400V/50 Hz</b>



Opzioni	Optionals	Sonderzubehör	Options	Opcionales	
---------	-----------	---------------	---------	------------	--

Esecuzione con motore monofase • **Single-phase motor** • Moteur monophasé • Ausführung mit Einphasenmotor • Motor monofásico